

a proud community; where residents can call a safe, clean and attractive borough their home.

## POLICY COMMITMENT

**1. Create stronger neighbourhoods:** work with Kent Police on the prevention, detection and reduction of crime and anti-social behaviour, and the safeguarding of local residents.

Key work completed or supported by the CSU during Qtr 2 includes:

- A very successful week of activities were organised by the CSU with the support of a wide range of partner agencies during National Anti-Social Behaviour Week (18-13 July) to raise awareness of ASB and other community safety issues, encourage reporting and provide reassurance. 'Pop-up' community engagement events took place across the Borough and culminated in a multi-agency day in Woodlands Park at the end of the week involving Kent Police, Kent Fire & Rescue Service, Stop The Traffik, G-Safe Business Crime Reduction Initiative, Charlton Athletic, Northfleet Youth Hub, Olympia Boxing, Gravesham Sanctuary. The day was very well-attended and received very positive feedback from the public. During the week, bike marking sessions saw 44 bikes security marked, free dog micro-chipping took place and over 150 people attended an on-line training session to raise awareness of extremism/radicalisation and how to recognise signs and report.

- Gravesham's CSU bid to the Home Office Safer Streets Fund Round 4 (completed in conjunction with the Office of the Kent PCC) was successful and just over £60,000 has been granted to contribute to the cost of works to continue to improve safety in Gravesend town centre. 8 new permanent CCTV cameras have already been purchased for installation in parts of the town centre with little/no coverage at present. 20 new radios have also been purchased for use by the G-Safe Business Crime Reduction Initiative that are being made available to businesses to have a 6-month free trial and work has commenced to improve radio signal quality to enhance communication between business staff, Kent Police, and the CCTV Control Room. Good progress is also being made in working with business with the aim of creating 'Safe Spaces' within business premises that will be available to anyone in the town centre (both during the daytime and night-time) who feels vulnerable and needs some assistance. A programme of improvements to 37 streetlights is also being agreed following planning approval and designs having been approved in September.

- In September, a One Stop Shop service has begun to run at the Woodville every Thursday morning between 10.00-12.00 whereby anyone either experiencing domestic abuse directly or who is a concerned third party, can drop in to get advice and support.

- The Council's Annual Modern Slavery Statement has been updated for publication on the Council's website and provides details of key work that has been completed to address this issue during the previous 12 months. The approach taken to tackling Modern Slavery in Gravesham has been recommended as a good practice model with other Kent Districts now also hoping to establish multi-agency Modern Slavery Working Groups.

- Following the lifting of C-19 restrictions, the reopening of businesses and a return to life as 'normal', crime levels were expected to rise quite quickly to pre-pandemic levels both locally and nationally. Encouragingly, Gravesham has seen one of the smallest increases across the county and the trend is one of crime locally rising at a slower pace than in the majority of Kent Districts. For the year ending 30 September 2022, crime locally is at a lower level than it was in years immediately prior to the pandemic. There was an unusually higher than average level of ASB incidents reported in August (270 incidents) but this may also be a positive indication of the considerable efforts made in July to encourage reporting.

### PI 1 Total number of reported crime offences

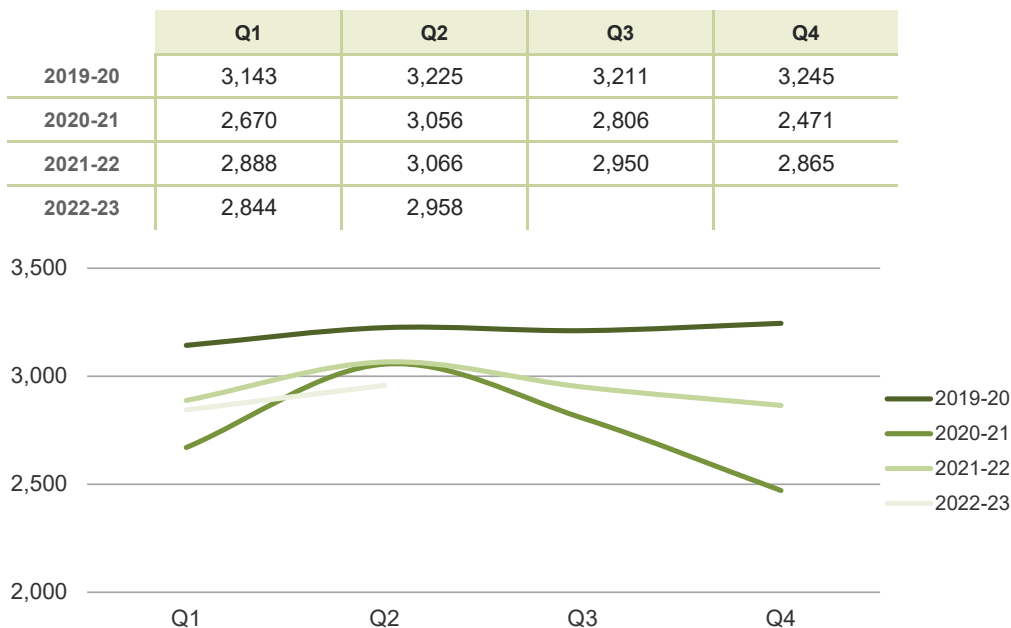

### PI 2 Total number of reported incidents of Anti-Social Behaviour

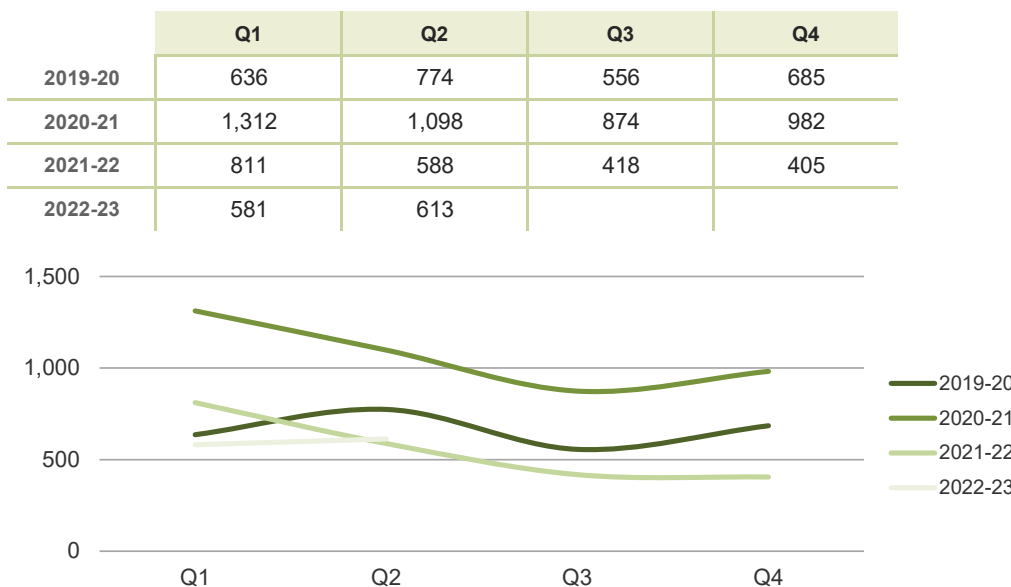

a proud community; where residents can call a safe, clean and attractive borough their home.

## POLICY COMMITMENT

**2. Actively enforce environmental standards:** use available powers to pursue anyone committing environmental crime or damaging the local environment.

In quarter 2 2022/23, the team has continued its enforcement activity in the community by issuing:

- 81 Community Protection Notice warnings predominately for waste out early/ presentation issues.
- 3 Community Protection Notices have been issued, with 2 of these are in relation to burning and illegal waste processing at Fowlers Stone Woods in Vigo.
- 21 Fixed Penalty Notices: Fly tipping - 12, FPN Duty of care - 7, FPN Failure to produce transfer notes - 1 and Breach of Community Protection Notice - 1.

The team has also dealt with the following case load: July 44, August 47, and September 42. There are a number of cases with the legal team awaiting court and in the last 3 months there have been several successful prosecutions.

We currently have an establishment of 1 x Street scene Enforcement Officer, 2x Environmental Crime Officers and an investigator. Recruitment for a second SSEO is in progress. Sickness and leave commitments have had an impact on productivity over the quarter.

It has now been confirmed that KCC will finance the Operation Assist joint operations with Kent Police and during Q2 a single operation was carried out. In addition the team has continued to work with Kent Special Constabulary on Operation Nightjar aimed at 'out of hours' fly tipping. Both operations have resulted in enforcement action and positive interaction with law abiding members of the community.

## PI 13 Total number of environmental enforcement actions taken

	Q1	Q2	Q3	Q4
2019-20	17	16	28	19
2020-21	0	7	44	79
2021-22	99	75	82	51
2022-23	74	105		

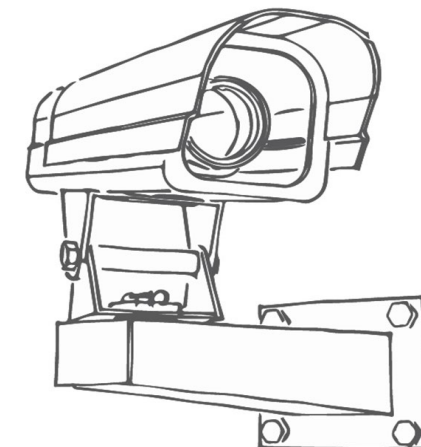
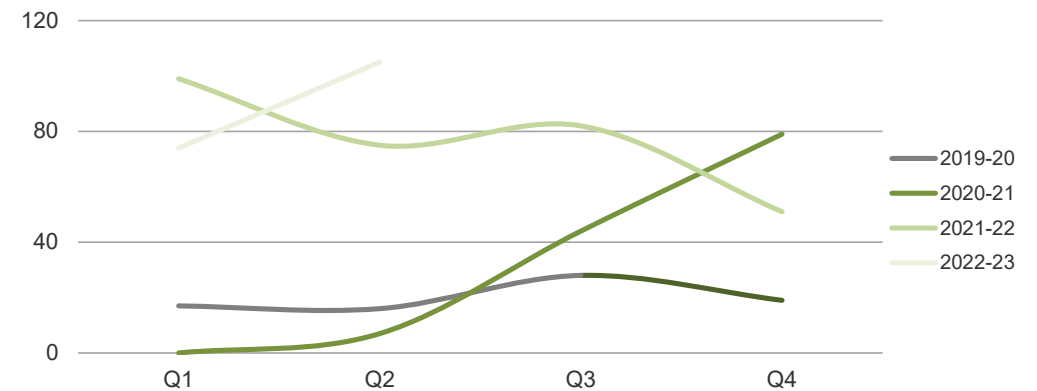

## POLICY COMMITMENT

**1. Design a quality and affordable leisure offer:** improved facilities and creative sports programmes to tackle local health inequalities.

### Leisure Centres

- Swimming at Cascades did extremely well over the summer out performing 2019.
- Gym usage is fluctuating between the sites and remains around 50% of the 2019 levels.
- Group Classes at Cygnet rose to 63% during this quarter, GCLL have cut underperforming classes and reviewed the programme during this period.
- Health Suite usage at Cascades is at 47% of the levels recorded in 2019
- Swimming lessons at Cygnet are exceeding pre-Covid levels and Cascades is now at 74%.
- School Swimming continues to grow and is also at around 75% of the pre pandemic levels.
- Social lettings - services are not fully resumed, particularly at Cascades. This continues to be built upon.

### Active Gravesham

After a two year absence due to the coronavirus pandemic, GBC were able to deliver a full Summer Fun Programme during the school summer holidays. GBC Park Life events, ran across a number of park sites in the borough (Prom, Higham, Cascades and Camer) and included climbing wall, bouncy castle, kangoo jumps, football, human hungry hippos. Other activities fully or part funded by GBC included fishing, martial arts, basketball and partnership projects such as nature trails with the North West Kent Countryside partnership, football sessions with Northfleet Big Local, Riverside Community Centre Family Fun Day and Street Dance Workshops with Team Kaizen at Cascades Leisure Centre.

The guide also promoted activities provided by local sports clubs/organisations including wheelchair rugby, crash course swimming, tennis, dance and circus acrobatic workshops. During the summer over 5000 people took part in the activities advertised in the guide.

Outside of the Summer Fun programme there were Active Gravesham sessions for adults including Learn 2 Ride bike sessions and walking hockey.

As part of this year's Riverside Festival an 'Active Area' was setup offering participants the opportunity to take part in activities including laser tag, crazy golf, bmx, climbing wall and more.

a dynamic borough; defined by a vibrant and productive local economy taking advantage of growth in the area, supported by its strong and active community.

PI 37 Total number of leisure centre attendees

	Q1	Q2	Q3	Q4
2019-20	219,508	207,957	194,043	204,620
2020-21	N/A	41,278	39,391	2,901
2021-22	74,427	102,871	105,621	130,700
2022-23	129,618	125,384		

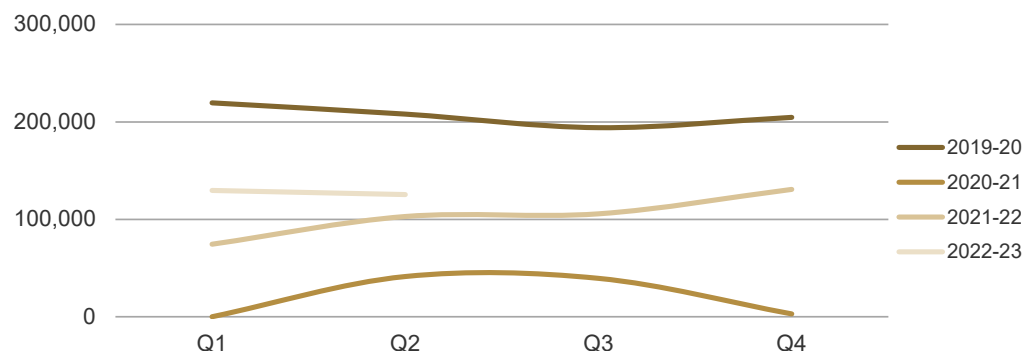

PI 38 Total number of 'Active Gravesham' attendees

	Q1	Q2	Q3	Q4
2019-20	Annual indicator			7,318
2020-21	Annual indicator			551
2021-22	Annual indicator			1,514
2022-23	Annual indicator			

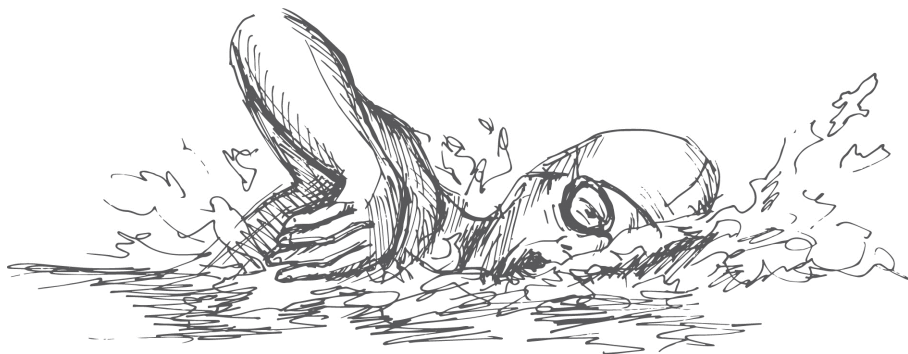
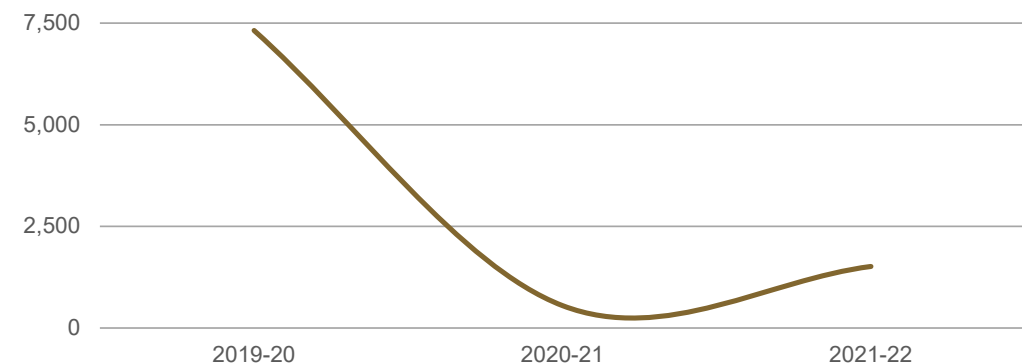

## POLICY COMMITMENT

**2. Manage a programme of proactive healthy living interventions:** work with partners to help support and safeguard vulnerable residents.

On September 1st 2022 The Healthy Living Centre (HLC) moved into the Community Centre behind the Methodist Church. Our new address is c/o The Methodist Church Community Centre, 4-9 Wilfred Street, Gravesend, Kent, DA12 2HA. The phone number has remained the same 01474 320123.

To allow for the move, the HLC Sessions stopped at the Old Courthouse during August. All sessions in the HLC and across the borough are back up and running and all details of the services can be found at [www.thegrand.org.uk](http://www.thegrand.org.uk)

**One You Weightloss** This quarter we engaged with 218 participants with a completion rate of 73% (160 people). 132 of those completers lost weight from their initial contact date.

**One You Lifestyle Advisor** This Quarter 227 people were supported by a One You Lifestyle Advisor to improve their physical or mental wellbeing.

**National Diversity Awards** – From 75,000 organizations nominations, The Grand Healthy Living Centre and all the work delivered within it, was shortlisted for a National Diversity Award in the category – Community Organisation for Age. Whilst not winning the category this is a huge achievement for the team and gives the work delivered through the Healthy Living Centre national recognition.

**Life Choir at Gravesham Riverside Festival** - The Gr@nds choir is delivered as a partnership between One You, Involve Kent and the Healthy Living Centre. The intergenerational performance saw 45 people from The Adult Singing group and Gifted Young Gravesham, perform 2 songs at Gravesham Riverside Festival.

**Cha & Chat At the Sikh Gurdwara** – As part of the One You service, the Talk and Tea event was held to engage the Sikh community to have holistic conversations and signpost people to services as appropriate. The event was held at the Gurdwara with Punjabi speaking staff on hand to ensure that language was not a barrier to engagement.

37 people received a Health Check which informed the individuals Heart Age score and Coronary Vascular Disease risk indicator.

Another Cha and Chat will take place in Q3 around mental health to break down the stigma to talk about this important issue and signpost to specialist services such as counselling or community projects that improve overall health.

**Yoga – Hindu Mandir** - After the successful International Yoga Day taster in Q1, a regular monthly session is taking place at the Hindu Mandir. The community have taken on the session with donations from participants sustaining the tutor costs.

a dynamic borough; defined by a vibrant and productive local economy taking advantage of growth in the area, supported by its strong and active community.

**PI 40** Total number of people achieving a target outcome from the Gr@nd healthy living services

	Q1	Q2	Q3	Q4
2019-20	974	595	1,011	515
2020-21	353	417	414	386
2021-22	384	359	429	479
2022-23	552	509		

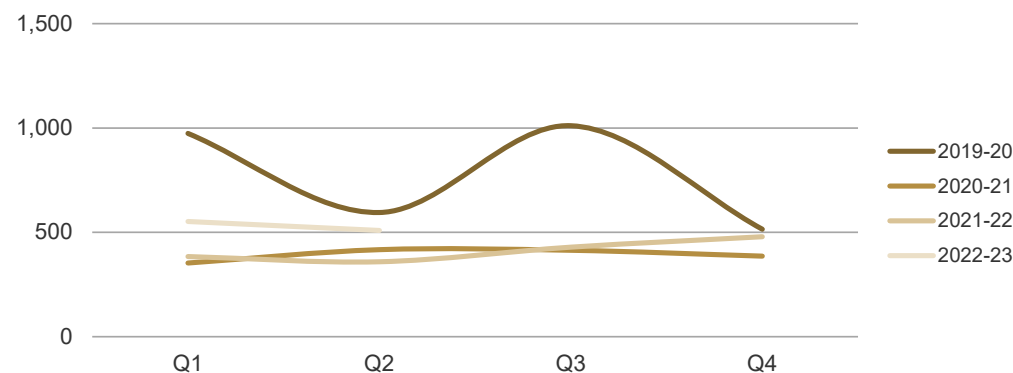

## POLICY COMMITMENT

**3. Develop a cohesive and resilient community:** implement a leading programme of engagement initiatives, showcasing the borough's diversity and enabling greater participation in civic life.

Council funding supported a summer event in Vigo and also identified GTown talent's desire to deliver a film screening of their film Unstuck raising awareness of domestic abuse.

Eid-al-Adha was celebrated with flag raising and prayers in Fort Gardens.

Gravesham Pride was celebrated on 13 August with flag raising and speeches on community square with a parade through the town to Fort Gardens.

In addition, x2 community litter picks were delivered during this period.

a dynamic borough; defined by a vibrant and productive local economy taking advantage of growth in the area, supported by its strong and active community.

PI 41

*Total number of community activities/events delivered by the council and in conjunction with its partners*

	Q1	Q2	Q3	Q4
2019-20	Annual indicator			36
2020-21				50
2021-22				74
2022-23				

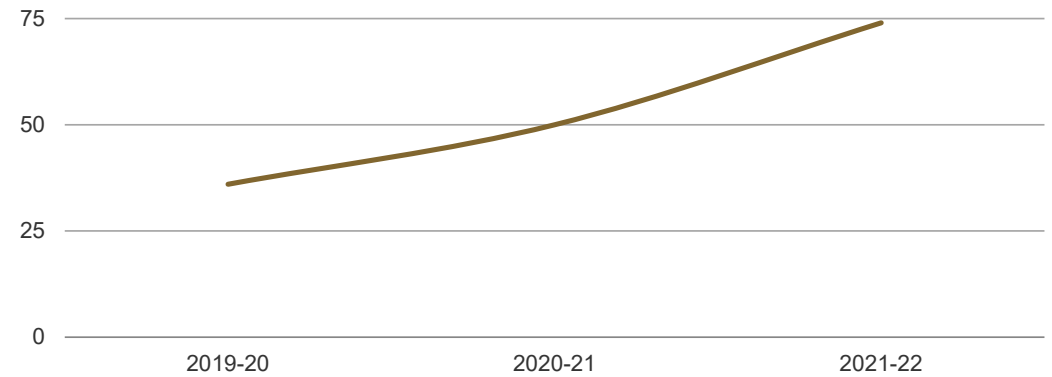

## POLICY COMMITMENT

**4. Enhance the borough's cultural offer:** maximise the usage of The Woodville and the Borough Market as community assets.

Q2 saw a full programme of events at The Woodville, with more cinema due to the summer months being unpredictable in terms of enthusiasm for coming indoors depending on the weather.

St George's Arts Centre has had a full exhibition programme with photography, an end of term exhibition by Gravesend Grammar School, an exhibition of local artists celebrating the Blooming Lovely Festival in town and Gravesend Art Groups annual exhibition.

St Andrew's Arts Centre has been in wide use for young people as part of the Ship and Shore activity with LV21.

The very popular culture camps ran throughout July prior to the schools breaking up and funding was allocated to this group from KCC reconnect for this group to attend performances of Bob the Superdog at The Woodville in August.

All the arts spaces have been widely used by the community for events, workshops and educational activities



a dynamic borough; defined by a vibrant and productive local economy taking advantage of growth in the area, supported by its strong and active community.

PI 42 Total number of patron tickets sold by The Woodville

	Q1	Q2	Q3	Q4
2019-20	10,658	12,358	21,127	6,968
2020-21	0	2,413	3,415	241
2021-22	715	5,172	12,693	11,958
2022-23	7,782	13,266		

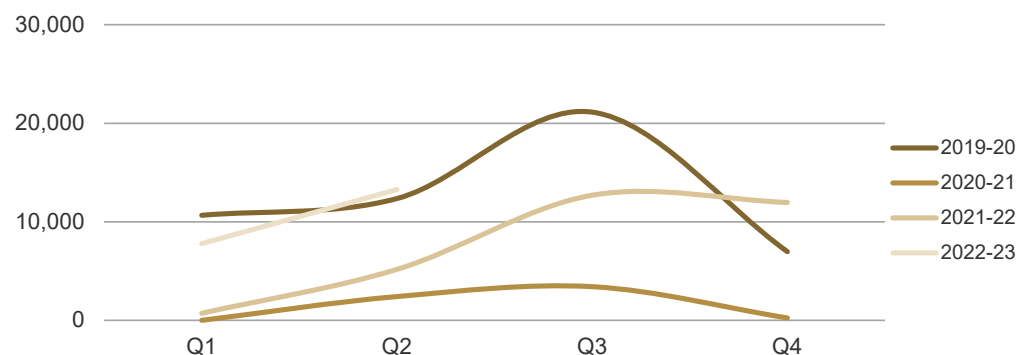

PI 43 Average weekly Borough Market footfall

	Q1	Q2	Q3	Q4
2019-20	6,419	6,801	6,857	7,461
2020-21	980	6,192	4,582	2,223
2021-22	4,785	6,729	6,808	6,025
2022-23	6,204	5,219		

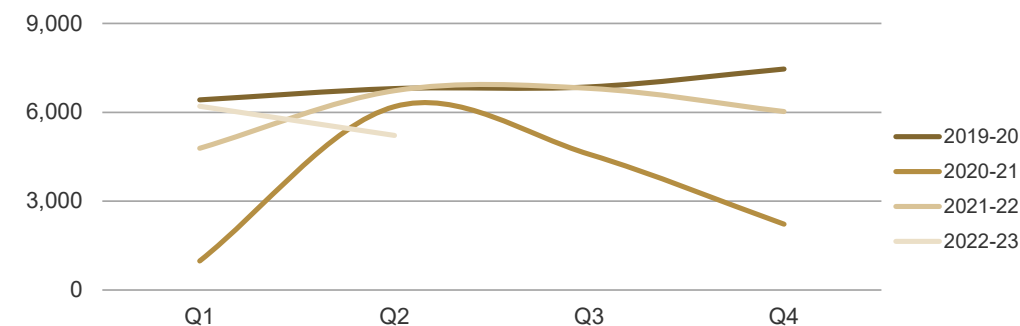

a dynamic borough; defined by a vibrant and productive local economy taking advantage of growth in the area, supported by its strong and active community.

## POLICY COMMITMENT

**5. Promote Gravesham's arts and heritage:** support local groups in their community reach and expand the visitor economy.

The heritage sites have reported a good steady flow of visitors this season following the prolonged closure during Covid. The number of events taking place in the Fort Gardens this summer has helped with the increase in visitor numbers and also attracted visitors from outside the borough.

The annual private hire 'Fort for Victory' event took place during the last weekend of September and Milton Chantry recorded 723 visitors. New Tavern Fort recorded similar visitor numbers. This event drew approximately 1,336 visitors both locally and from further afield.

The new General Gordon display has proved popular with visitors of all ages, so we are now looking to enhance and conserve the displays in other rooms to lengthen their display lifespan and make them more engaging and interactive.

Sadly Milton Chantry, New Tavern Fort, and Fort Gardens in general have seen an increase in anti-social behaviour mainly during the summer months. Both buildings have been targeted in various ways and the gardens have been a base for drug dealing and littering. These problems have been dealt with and plans are being developed to help protect the sites from a repeat of this next summer.

The Cold War bunker has continued to offer monthly tours, with on average 15 bookings per tour. Bookings are now being taken for tours commencing in January 2023.

### PI 44 Total number of visitors attending Gravesham heritage sites

	Q1	Q2	Q3	Q4
2019-20	Annual indicator			4,936
2020-21				0
2021-22				3,506
2022-23				

